

**SINGER** K1831  
(256) No. 28

INSTRUCTIONS  
FOR USING  
**SINGER\***  
SEWING MACHINE  
NO. 28  
VIBRATING SHUTTLE, FOR FAMILY USE

When requiring  
Needle, Oil,  
Parts or Repairs,  
for your Machine



Look for the  
Red "S"  
There are Singer  
Shops in every City

**THE SINGER MANUFACTURING CO.**

# SINGER

K1831  
(256) No. 28

## The Table of Contents

### Warning

To all whom it may concern  
Singer Service

It's sew easy by electricity

The Hand Attachment

Stop Motion

To Operate the Hand Machine

To Ensure Perfect Action of the Machine

To Set the Needle

To Thread the Needle

To Wind the Bobbin

To Remove the Shuttle

To Thread the Shuttle

To Replace the Shuttle

To Prepare for Sewing

To Commence Sewing

To Remove the Work

To Regulate the Tension

To Alter the Length of Stitch

To Change the Pressure on Material

To Turn a Corner

To Sew Flannel or Bias Seams

To Oil Machine

### Hints

Needles Breaking

Thread Breaking

Skipping Stitches

Stitches Looping

Material Puckering

### Instructions for Using Attachments

Bias Gauge

The Binder - Binding

To Bind with Dress Braid

To Make French Folds

The Adjustment and Operation of the Binder

Binding Outside Curves

Binding Inside Curves

The Quilter

The Foot Hemmer - Hemming

Hemming and Sewing

on Lace in One Operation

The Foot Hemmer - Felling

The Adjustable Hemmer

The Adjustable Hemmer - Wide Hemming

The Under Braider - Braiding

# SINGER

K1831  
(256) No. 28

## WARNING

It is essential that your machine should be kept well oiled, in accordance with the instructions given on pages 13 and 14 of this book.

**SINGER Oil**, which is specially prepared for sewing machines, is supplied in tins which have the well-known SINGER Red "S" printed thereon.

**SINGER** Needles are stamped with the Trade Mark SIMANCO\* and are sold in green packets which also bear the SINGER Red Letter "S."

Needles in Containers marked " For Singer Machines " are not SINGER made needles.

Should your machine require overhauling or repair, apply only to a SINGER SEWING CENTRE or SINGER Salesman, otherwise you will risk its being irretrievably damaged.

*Every description of sewing machine repaired,*

## To all whom it may concern:

The improper placing or renewal of the trademark "SINGER" or any other of the trademarks of The Singer Manufacturing Company (all of which are duly Registered Trademarks) on any machine that has been repaired, rebuilt, reconditioned, or altered in any way whatsoever outside a SINGER factory or an authorised SINGER agency is forbidden.

## SINGER SERVICE

Now that you have purchased your new SINGER Sewing Machine we do not want you to feel that your relations with us have come to an end.

The following instructions are worded so that they may be easily understood by everyone, and we would suggest that you study them carefully in order that you may obtain the fullest use and pleasure from your sewing machine. If, however, you require further assistance we would ask you to call at the local SINGER SEWING CENTRE where advice will always be willingly given in the use of any SINGER Machine and its Attachments.

We hope, too, that you will make the SINGER SEWING CENTRE your headquarters for sewing supplies and service. Only there, or through SINGER authorized representatives, can you secure SINGER oil, cotton, needles, etc. all of which are so important in obtaining

# SINGER

K1831  
(256) No. 28

*It's sew easy by electricity!*

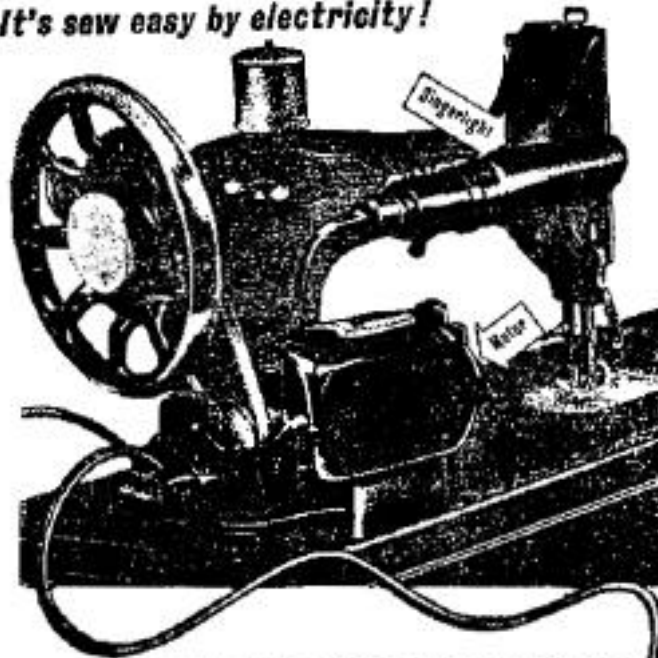

***convert your hand or treadle machine to  
speedy, effortless, all-electric sewing***

One screw attaches the Singer Motor.  
The convenient Foot Control starts and stops the  
motor instantly and regulates the sewing speed.  
The Singerlight, also fixed by one screw gives light  
where it is most needed . . . on the sewing. See,  
try and buy at your local Singer Sewing Centre.

**SINGER**  
motor and  
Singerlight



# SINGER

K1831  
(256) No. 28

## The Hand Attachment

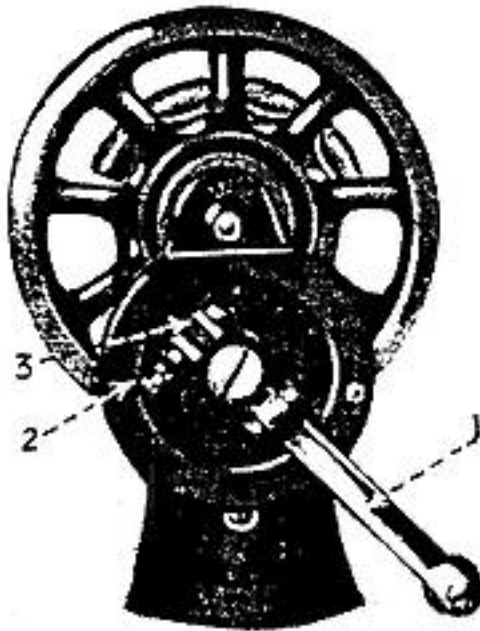

FIG. 1

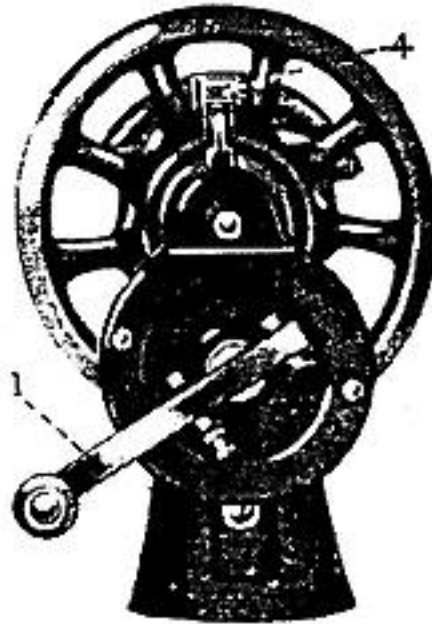

FIG. 2

When the cover is removed from the machine, the hand attachment will be found to be out of working position, as shown in Fig. 1.

To operate the machine, pull the small spring stud (2, Fig. 1) and turn the handle back until the lever (1, Fig. 1) enters the socket (3, Fig. 1); also see that the hinged finger (4, Fig. 2) is turned back between the spokes of the wheel. The machine will then be ready for working, as shown in Fig. 2.

Before replacing the cover, the lever should be disengaged, and the handle placed in the position shown in Fig. 1.

# SINGER

K1831  
(256) No. 28

## Stop Motion

This device allows the hand wheel to run free, so that bobbins may be wound without operating the mechanism. To loosen the wheel hold it with the left hand and with the right hand turn the stop motion screw over towards you, as shown in Fig. 3.

## To Operate the Hand Machine

Tighten the hand wheel (see Fig. 3) and place a piece of material under the presser foot (7, Fig. 5). Then lower the latter by means of the lifter (3, Fig. 5). Now turn the handle over from you to work the machine, without its being threaded, until you are accustomed to guiding the material with the left hand.



FIG. 3

# SINGER

K1831  
(256) No. 28

## To Ensure Perfect Action of the Machine

The hand wheel must always turn over towards you.

Do not work the machine with the presser foot lowered or with the shuttle and the needle threaded, except when sewing

Both slides over the shuttle must be kept closed.

## To Set the Needle

(See Fig. 4)

Raise the needle bar to its highest point and loosen the thumb screw.

(A). Hold the needle with the left hand and, with its flat side to the right, insert it into the needle clamp (B) as far as it will go. Then retighten the thumb screw.

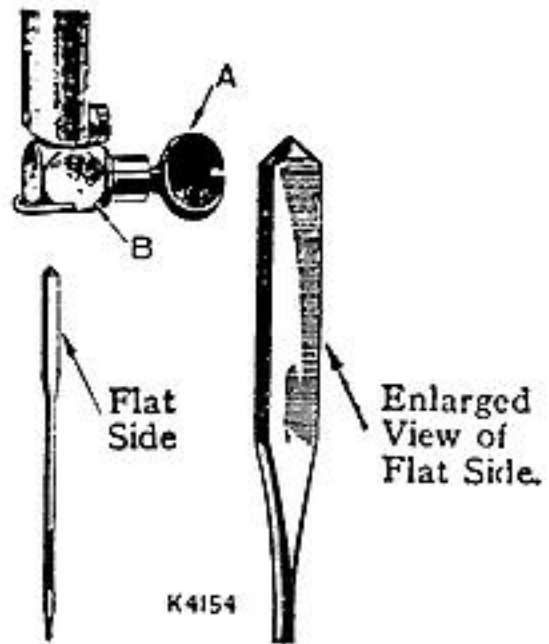

Fig. 4. Positioning Needle in Needle Clamp.



# SINGER

K1831  
(256) No. 28

## To Thread the Needle

(See Fig. 5)

Turn the hand wheel heel until the lever (2) is at its highest. Place a reel of thread on the spool pin and pass the thread through the notch (13) down, and from right to left under and between the tension discs (12), and up through the eyelet in the take-up spring (4). Then pass the thread from the front through the hole in the lever (2), down through the guard (5), into the guide (6), and **from left to right** through the eye of the needle. Draw about three inches of thread through the eye of the needle with which to commence sewing.

To obtain best results it is absolutely necessary that the needle used be of the size stated for the number of cotton, linen or silk, as shown on inside of back cover. If rough or uneven thread is used, or if it passes with difficulty through the eye of the needle, the machine will not function satisfactorily.

**The SINGER Needle Threader saves time, trouble and patience, and is invaluable to those having defective sight.**

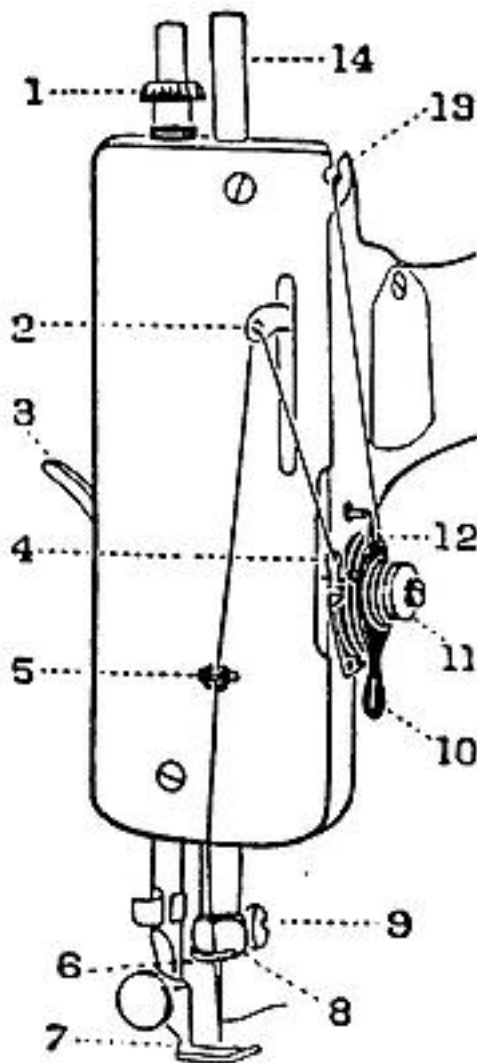

FIG. 5



# SINGER

K1831  
(256) No. 28

## To Wind the Bobbin

(See Fig. 6)

Loosen the hand wheel (see Fig. 3) and push the top of the winder from you until its rubber ring (5) just touches the ledge of the hand wheel. Turn the latter over towards you until the thread guide (2) moves to the extreme right. Place a reel of thread on the spool pin; and pass the end of thread through the notch at top of the face plate (13, Fig. 5); then thread the winder by passing the thread upward through the eyelet (1) and into the notch (2). Draw the knob (3) to the left, and place an empty bobbin between the cup at the right (4) and the centre hole at the left. Now clamp the end of thread between the cup and the end of the bobbin, turn the hand wheel towards you and wind by operating the machine as when sewing. When nearly full remove the bobbin by pulling the knob (3) to the left, then withdraw the winder from the ledge of the hand wheel and tighten the latter by turning the stop motion screw from you.

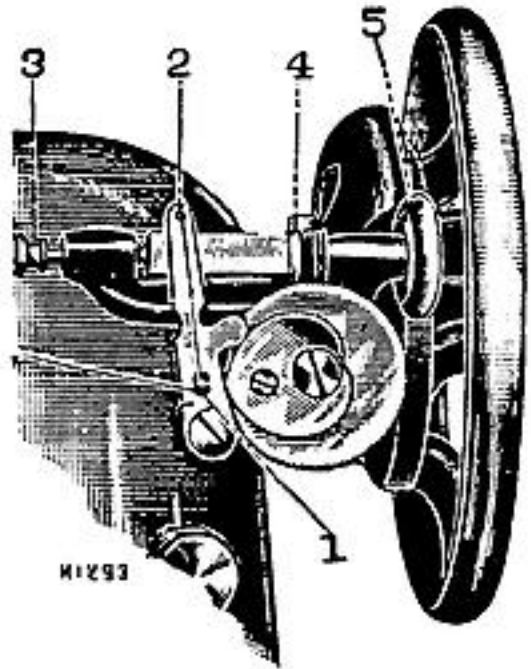

FIG. 6

# SINGER

K1831  
(256) No. 28

## To Remove the Shuttle

Open the front slide of the machine and turn the hand wheel towards you until the shuttle comes full under the opening. Press down the point of the shuttle with the thumb and lift out. Turn the open end of the shuttle downward and the bobbin will drop out.

NOTE: *The shuttle should not be lifted out by the spring.*

## To Thread the Shuttle

Hold the shuttle, as in Fig. 7, and insert the bobbin so that the end of the thread draws from the left towards the right, as shown in the illustration.

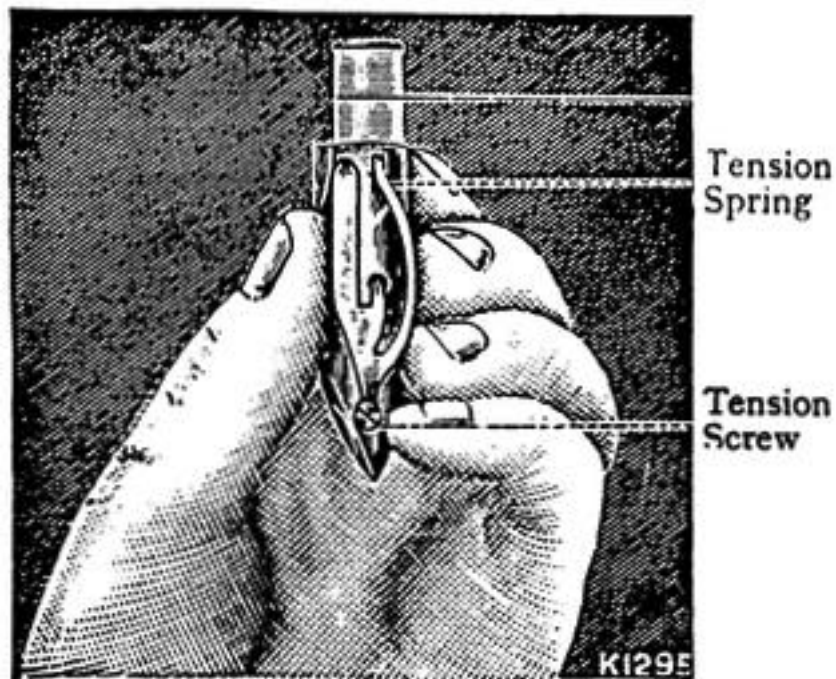

FIG. 7

# SINGER

K1831  
(256) No. 28

## To Thread the Shuttle Continued...

Place the forefinger of the left hand on the end of the bobbin, and draw the thread down into the slot of the shuttle, towards the point, as far as it will go (see Fig. 8); then pull the thread tightly upwards and down again, so that it lies across the point in the centre of the spring, as shown in Fig. 9.



FIG. 8

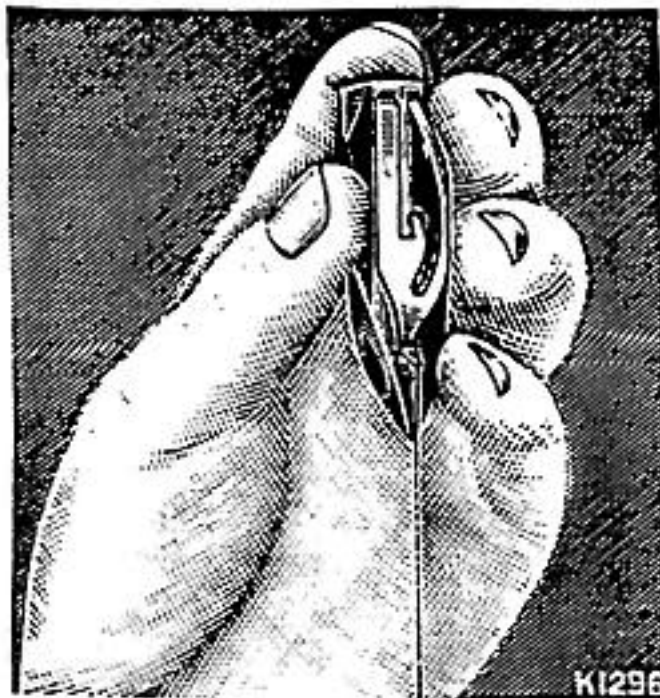

FIG. 8

# SINGER

K1831  
(256) No. 28

## To Replace the Shuttle..

After threading, take the shuttle in the right hand with its point towards you, and place it in the shuttle carrier, as shown in Fig. 10, leaving a loose end of thread about three inches long above the slide. Then close the latter.

NOTE: *Keep the inside of the shuttle and under the tension spring (see Fig. 7) free from accumulation of lint or dust.*

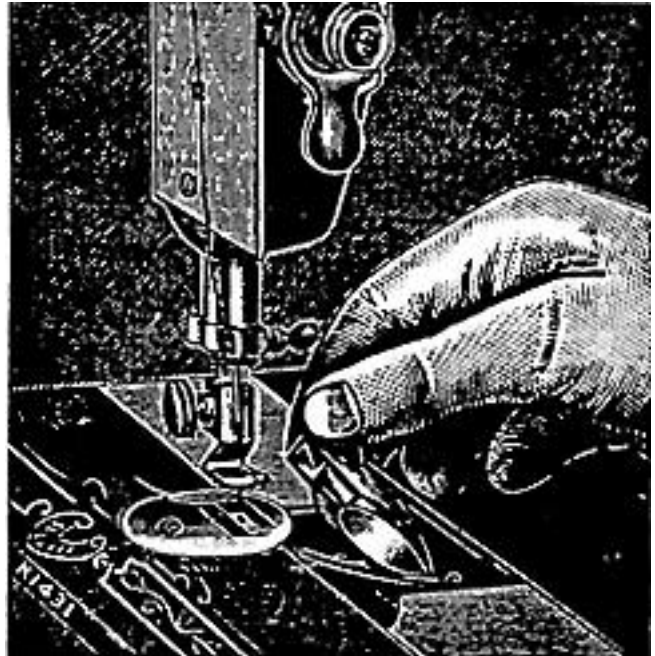

FIG. 10



# SINGER

K1831  
(256) No. 28

## To Prepare for Sewing

With the left hand hold the end of the needle thread, leaving it slack from the hand to the needle. Turn the hand wheel over towards you for the needle to move down and up again to its highest. Pull the thread you are holding, and the under thread will be brought up with it through the hole in the throat plate, as shown in Fig. 11. Place both ends of thread under and to the back of the presser foot.

## To Commence Sewing

Place the material to be sewn beneath the presser foot, lower the latter, and commence to sew by turning the hand wheel over towards you.

**NOTE:** Do not try to help the feeding of the work by pulling the material, as this may deflect the needle and cause it to break. The machine feeds without any assistance.

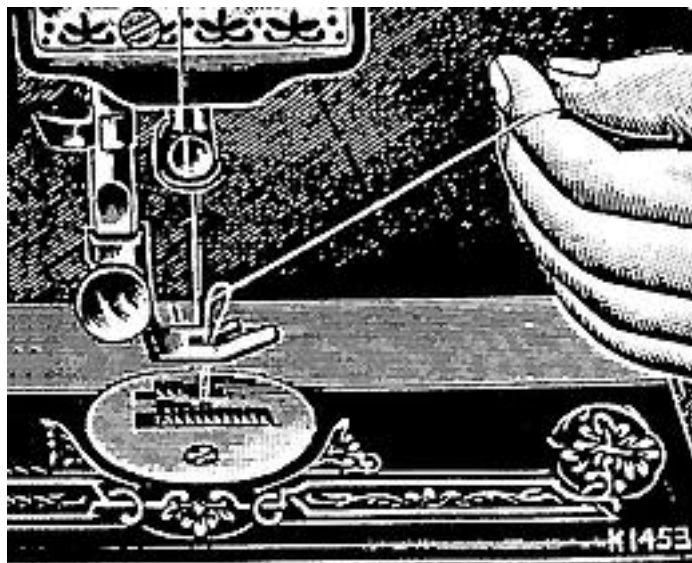

FIG. 11

## To Remove the Work

Raise the needle bar to its highest, lift the presser foot (7, Fig. 5), at the same time pressing the tension release (10, Fig. 5) with the thumb of the right hand. Move the material back and to the left, and sever the threads by passing them over the thread cutter above the presser foot. Leave a few inches of thread under and at the back of the presser foot.

# SINGER

K1831  
(256) No. 28

## To Regulate the Tensions



Correct Stitch.

For ordinary stitching, the tension on the upper and under threads should be equal, so as to lock both threads in the centre of the work, as above.

If either tension is stronger than the other, imperfect stitching will be the result, thus:



Needle Thread Tension  
too strong.



Needle Thread Tension  
too weak.

Fine fabrics require a light tension, while heavy materials want more tension to obtain a perfect stitch.

*The tension on the needle thread should be regulated only when the presser foot is down.*

A correct stitch can usually be obtained by varying the tension on the needle thread (see Fig. 12).

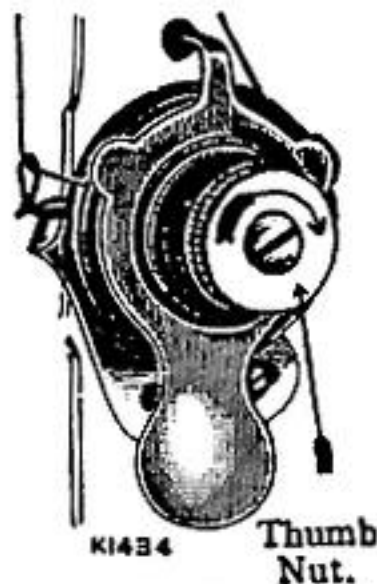

FIG. 12

Lower the presser foot and turn the thumb nut in the direction illustrated by the arrow to increase the tension or in the opposite direction to lessen it.

As all machines are correctly adjusted before leaving the factory, the under tension seldom requires to be altered, but if this becomes necessary tighten the screw near the point of the shuttle (see Fig. 7) to increase the tension, or loosen it slightly to lessen the tension.

*Always use thread with corresponding size of needle as per Table on page 3 of cover.*

# SINGER

K1831  
(256) No. 28

## To Alter the Length of Stitch

Turn the thumb screw inwards (see Fig. 13) to lengthen the stitch, or turn outwards to shorten it.

## To Change the Pressure on Material

For ordinary family sewing it is seldom necessary to change the pressure on the material. If sewing fine silk or flimsy material, lighten the pressure by giving the thumb screw (1, Fig. 5) two or three turns upwards. To increase the pressure, give the thumb screw a few turns downwards.

## To Turn a Corner

Stop the machine when the needle is rising, but still in the material. Raise the presser foot and turn the work, using the needle as a pivot. Then lower the presser foot.

## To Sew Flannel or Bias Seams

Use a short stitch and as light a tension as possible on the needle thread, so that the stitching will be loose enough to allow the material to stretch.

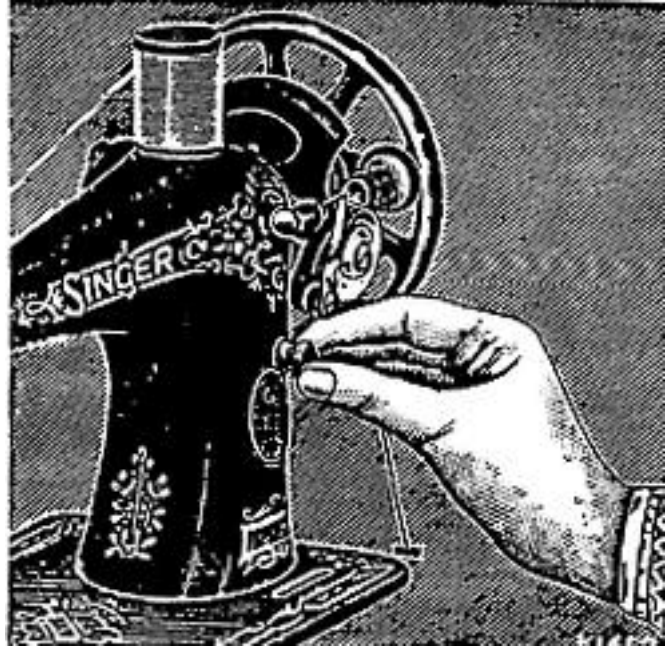

FIG. 13



# SINGER

K1831  
(256) No. 28

## To Oil the Machine

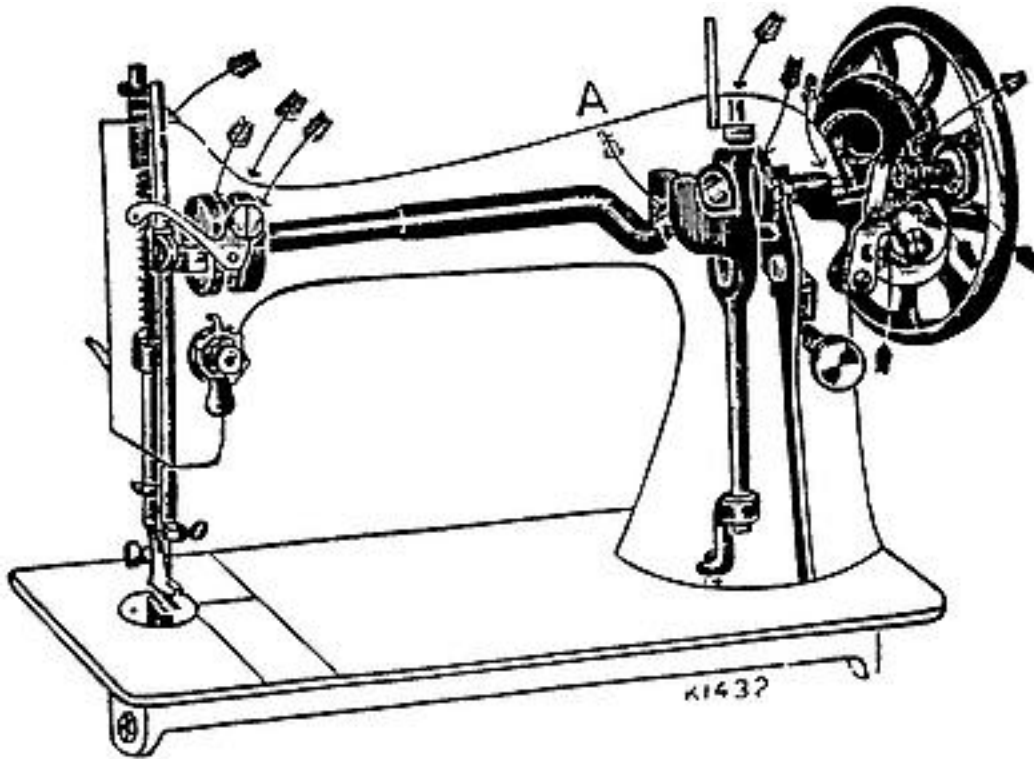

FIG. 14

To ensure easy running the machine requires to be oiled so that all moving parts in contact are covered with a film of oil. These should never be allowed to become dry.

If used constantly, the machine should be oiled daily, while with moderate use, an occasional oiling is sufficient. A drop of oil applied at the points indicated by arrows in Figs. 14 and 15 is sufficient. The small plate in front of the machine and the larger plate at the back should both be turned up and oil applied to the parts exposed. It is important that oil be applied to point "A," Fig. 14, when the take-up lever (2, Fig. 5) is at its lowest, and a little oil rubbed over the surface of the shuttle race. There are also two holes in the hand attachment to which oil should be applied occasionally. When oiling, insert the oil can spout well into the holes.

# SINGER

K1831  
(256) No. 28

To Oil the Machine continued...

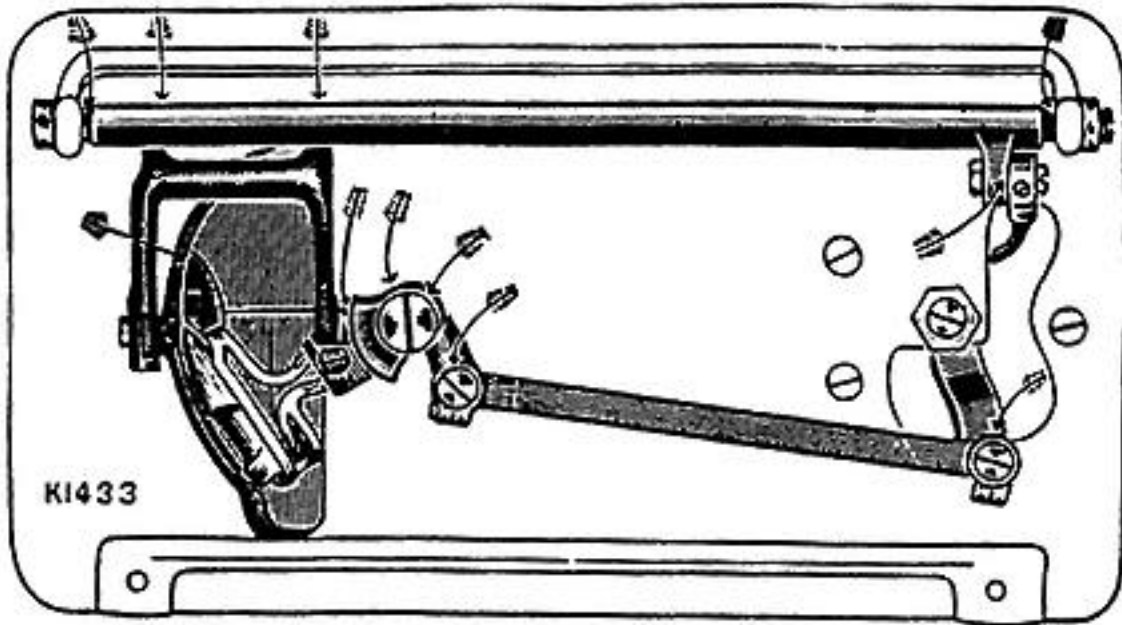

FIG. 15

After oiling, run the machine rapidly for a few minutes so that the oil may reach the bearings. Neglect to oil the machine will shorten its life and cause you trouble and annoyance.

**Always use SINGER oil. Inferior oil clogs the bearings, prevents efficient working, and causes rapid wear of the mechanism.**

## HINTS.

### **Needles Breaking.**

See that the needle is not bent, the upper tension is not too tight, and the presser foot or attachments are securely fastened. Avoid pulling the material and do not sew heavy seams or thick goods with too fine a needle (see table on inside of back cover).

### **Thread Breaking.**

If the needle thread breaks, see that:

The machine is properly threaded.  
The upper tension is not too tight.  
The needle is not bent, blunt or set incorrectly.

The thread is not too coarse for the needle (see table on inside of back cover).

The thread take-up spring (4, Fig. 5) is not broken.

Should the under thread break, loosen the under tension (see page 11), and see that the shuttle and under the tension spring are free from fluff.

### **Skipping of Stitches.**

See that the needle is correctly set (see page 5), is not blunt, bent, or too fine for the thread.

### **Stitches Looping.**

See that the spring (4, Fig. 5) is not broken, that the upper and under tensions are equal, that both shuttle and needle are properly threaded, that the thread is of good quality and of correct size for the needle (see table on inside of back cover).

### **Material Puckering.**

See that both tensions are equal.

# **SINGER** K1831 (256) No. 28

**INSTRUCTIONS  
FOR USING  
ATTACHMENTS  
WHICH MAY BE USED WITH  
SINGER\*  
SEWING MACHINE  
No. 28**

NOTE. *Before applying any of these attachments raise the needle and remove the presses foot. After substituting the attachment turn the hand wheel slowly over towards you to make sure that the needle passes through the centre of the needle hole.*

Darning by sewing machine is infinitely neater, stronger, and more quickly done than by hand.

*A tiresome task becomes a pleasure!*

Read how to do this in separate pamphlet, Form 1001 ad 33, which maybe obtained free from any SINGER SEWING CENTRE or Singer Salesman.

# SINGER

K1831  
(256) No. 28

## Bias Gauge

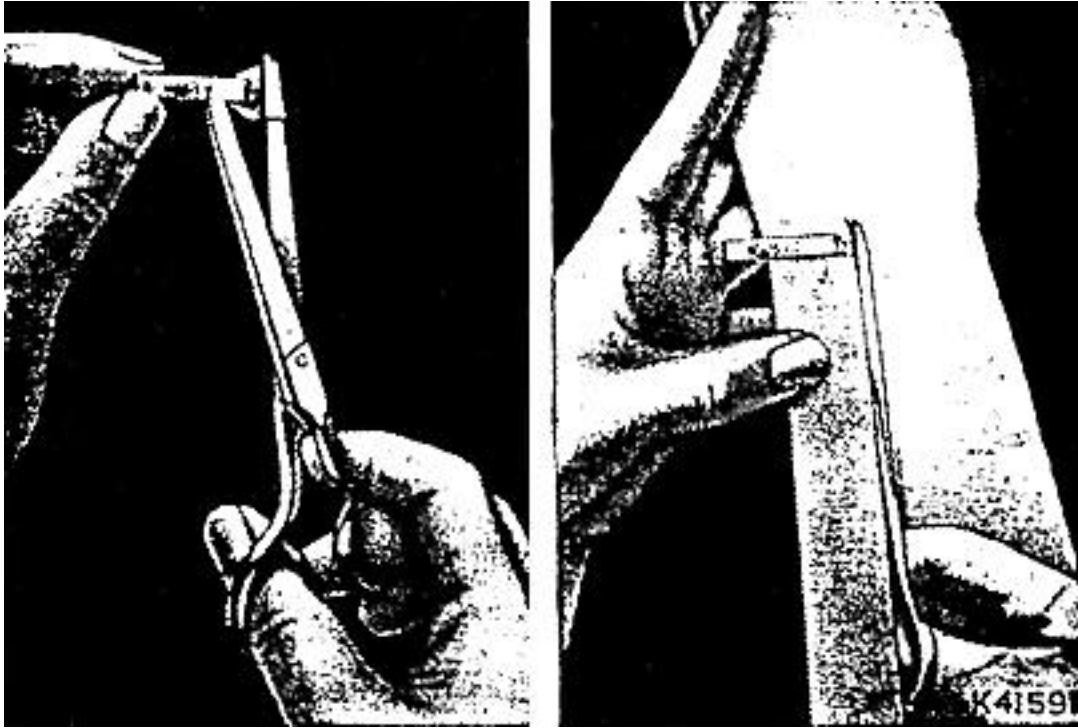

The Bias Gauge will be found very useful (especially in the case of soft materials) when cutting bias steps from  $\frac{7}{16}$  inch to  $1 \frac{3}{8}$  inches in width. This may be done by placing the bias gauge upon the point of the scissors and setting the blued indicator to the width desired. The line **F** is the point at which to set the blued indicator for facings, the line **B** for binding, and the line **C** for cording or piping.

Insert the material in the gauge with the edge against the blued indicator, and hold as shown above.

Bias binding for use with the Binder Attachment should be cut  $\frac{15}{16}$  inch wide, and to do this the indicator should be set midway between the lines **F** and **B**.

# SINGER

K1831  
(256) No. 28

## The Binder - Binding

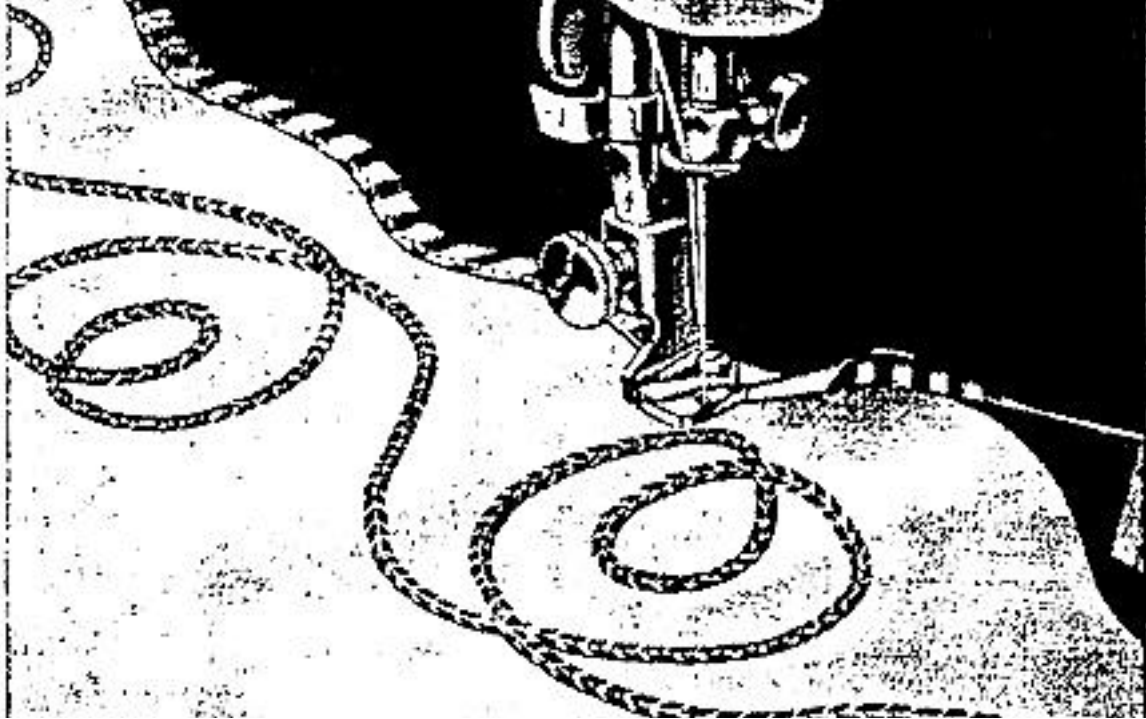

Pass the binding through the scroll of the binder and draw it under the needle. Place the edge of the material to be bound between the scroll of the binder and under the needle, lower the presser-bar lifter and sew as usual.

Bias binding should be cut  $\frac{15}{16}$  of an inch wide.

**To Bind with Dress Braid.** - Proceed as when using bias binding; but as dress braid and binding purchased already folded are narrower than bias binding they should be inserted in the outer slot of the binder. The edges of dress braid are not turned under as in the case of bias binding.

**To make French Folds.** Proceed as directed for binding, but pass the cloth beneath the binderfoot, so that the fold is stitched on to the face of the material instead of on the edge.

# **SINGER** K1831 (256) No. 28

## **The Adjustment and Operation of the Binder**

The edge to be bound should be held well within the centre slot of the scroll, and with a little practice this is quite easy. If the material is allowed to slip away from the scroll when near the needle, the edge will not be caught in the binding.

Various materials and conditions require different adjustments of the Binder to bring the stitching close to the edge. A wider adjustment of the Binder is necessary when binding curves than when binding a straight edge.

To adjust the Binder, loosen its small screw and move the scroll to the right for a narrower adjustment, or to the left for a wider adjustment, after which securely tighten the screw. To become perfectly familiar with the adjustment of the Binder, a little practice is necessary.



## Binding Outside Curves

Practice is required to bind a curved edge properly.

The edge to be bound must be allowed to pass freely through the scroll and should not be crowded in or against it. Guiding should be from the back of the binder and to the left, allowing unfinished edges to swing naturally into the scroll of the binder.

Never pull the binding as it feeds through the Binder, as bias material is very easily stretched and would be too narrow when it reaches the needle. If this occurs the edges will not be turned.

When binding a curved edge, turn the material only as fast as the machine sews. It is not possible to hold the material in the entire length of the scroll when binding a small curve.

Do not push the material in too fast, as the edge will then become puckered, and do not stretch the material or the curve will not be the proper shape when finished. If the stitching does not catch the edge of the binding the scroll should be adjusted a little to the left.

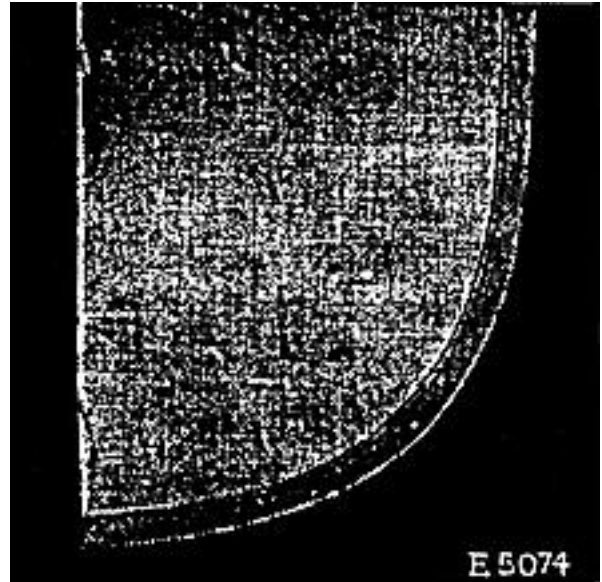

Sample of Outside Curve.

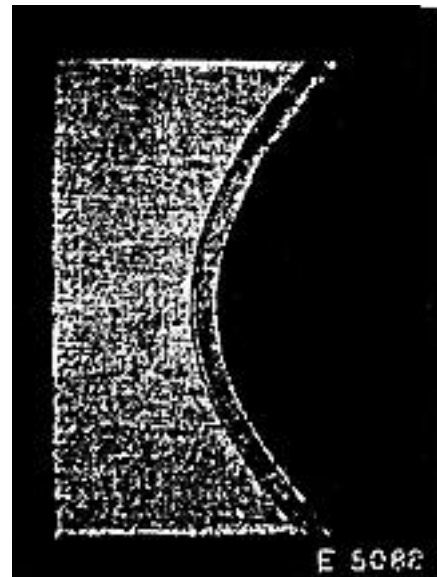

Sample of Inside Curve.

# **SINGER** K1831 (256) No. 28

## **Binding Inside Curves**

This curve is found on nearly all garments which are finished with a bound edge, but practice is necessary on venous materials.

When binding an inside curve, straighten out the edge as it is being fed into the Binder. When doing this, take care not to stretch the edge of the material.

If the material is soft, like batiste or crepe de chine, add a row of machine stitching close to the edge of the curve before binding.

# SINGER

K1831  
(256) No. 28

## The Quilter

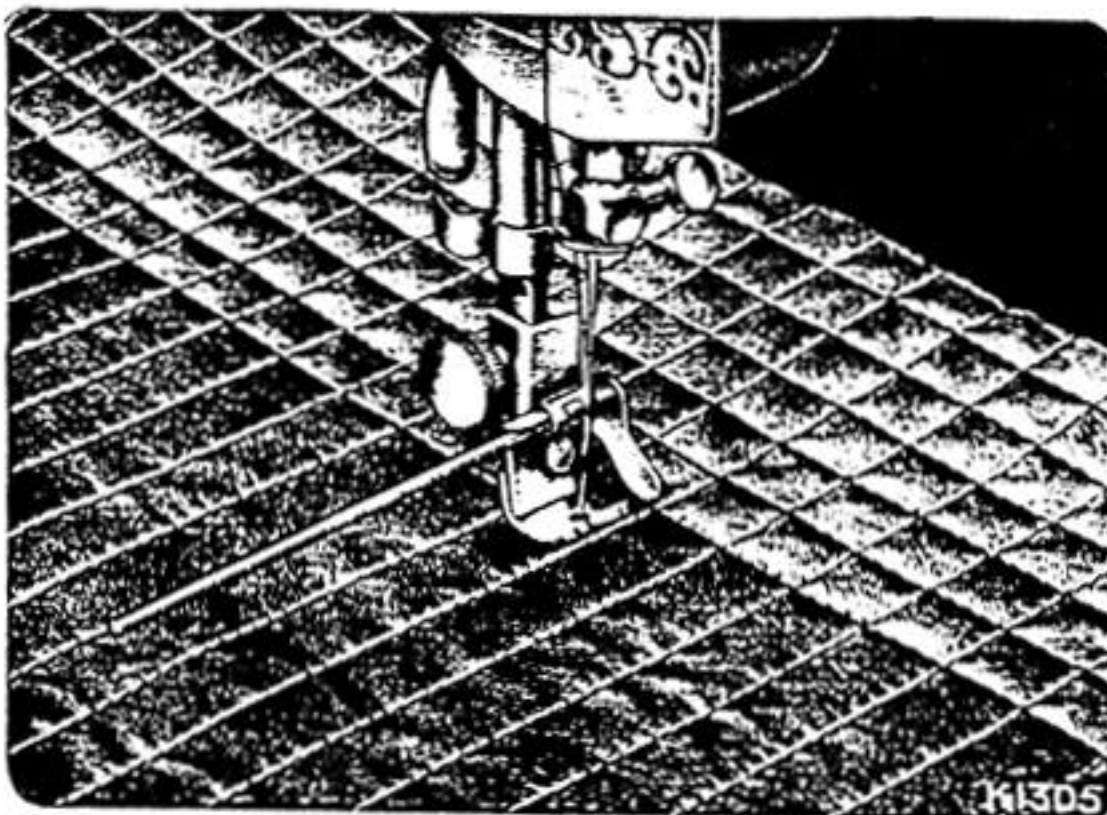

The quilter guide can be used at either the right or left of the needle, and the distance of the guide from the needle determines the width between the rows of stitching. Slide the wire into its holder on the foot, and set it to the width desired; then lower the foot on to the material.

**To Quilt.** - For the first row of stitching, let the quilter guide follow the edge of the material, a straight crease, or a line, as preferred. Succeeding rows are made straight and at a uniform distance by keeping the previous row steadily under the guide, as shown.

# SINGER

K1831  
(256) No. 28

## The Foot Hemmer -- Hemming

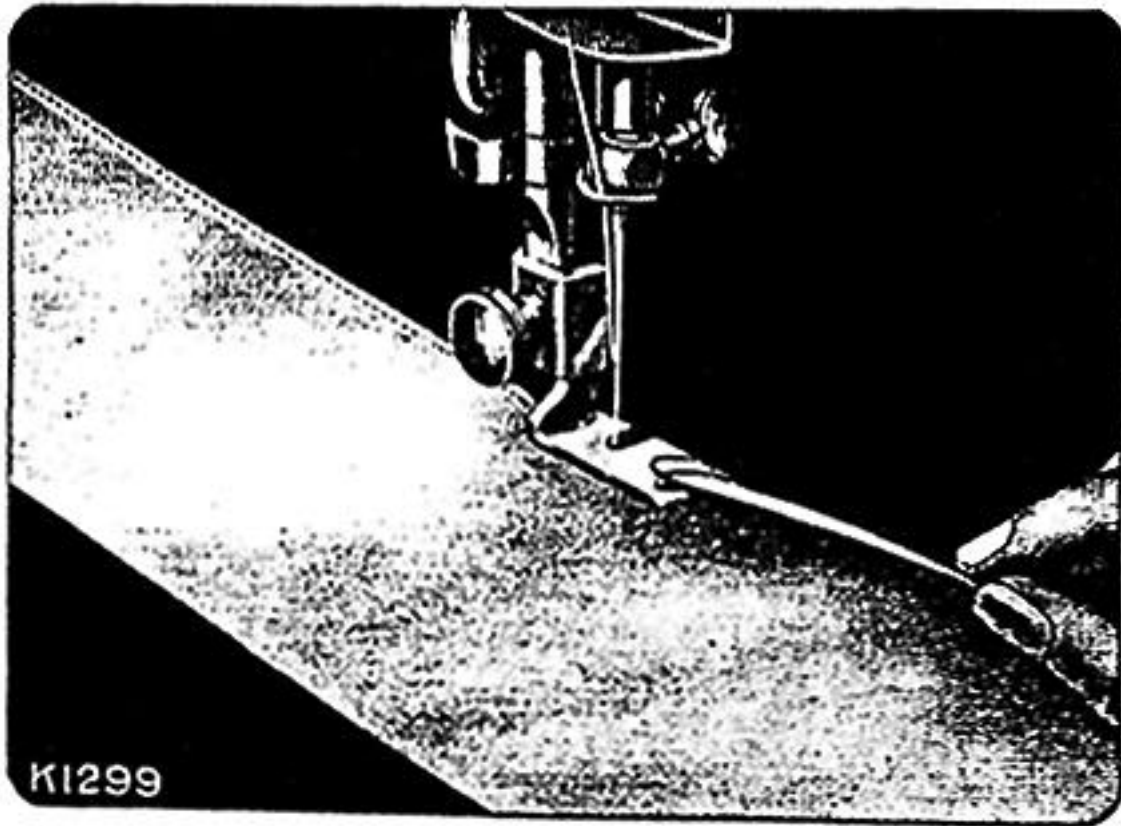

Clip off the right hand corner of the material for its edge to curl easily. Then, with the hemmer foot raised, place the material from left to right under the foot and, with its edge slightly raised, insert the corner into the mouth of the hemmer, easing it along until it fills the curl and reaches the needle. Lower the foot and make the first few stitches slowly. Guide the material with the thumb and forefinger of the right hand, so that the edge lies flat over the top of the hemmer, and proceed to sew, taking care to keep the hemmer curl just full. Should the edge begin to run out, move the hand to the left; **should too much material run in, move to the right.**



# SINGER

K1831  
(256) No. 28

## Hemming and Sewing on Lace in One Operation

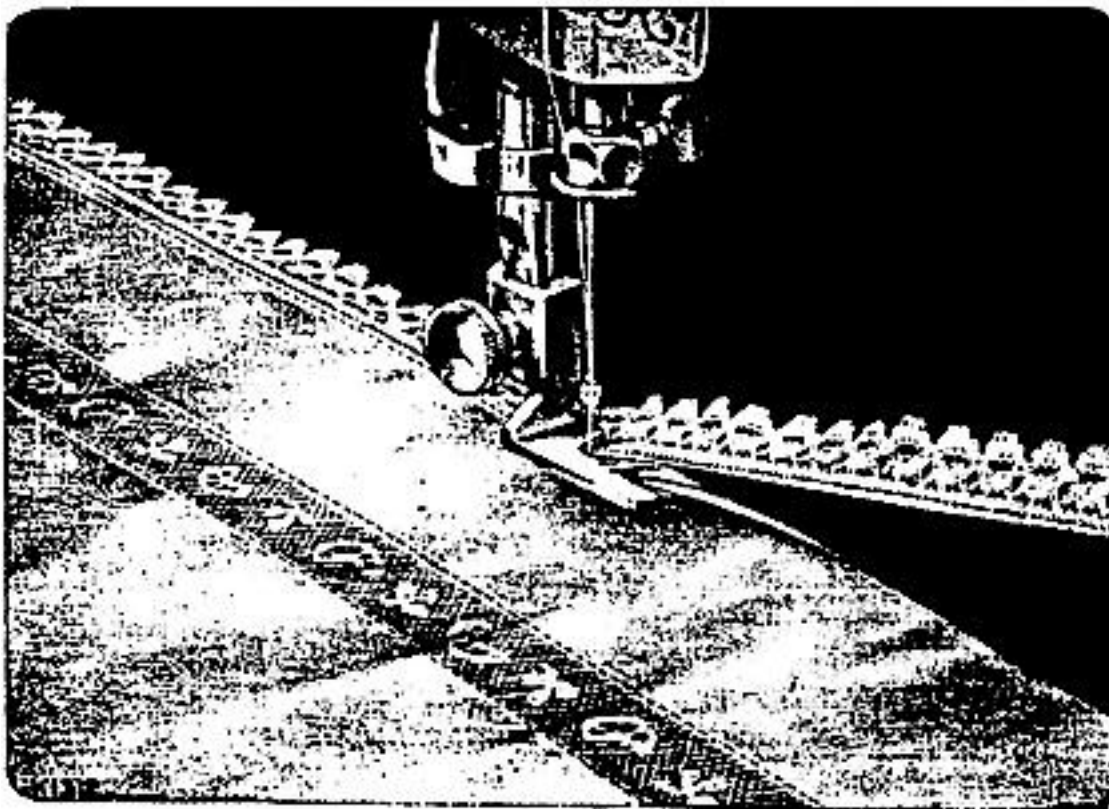

Start the hem and, when it is well started, raise the needle to its highest point. Raise the hemmer to relieve the pressure on the hem, and pass the end of the lace through the slot in the side of the attachment and over the hem, as shown.

Take care that the hem is not displaced in the hemmer, and that the needle goes through both the lace and hem. Then let down the presser bar and guide the lace over the front of the hemmer, taking care to keep it well into the slot.

# SINGER

K1831  
(256) No. 28

## The Foot Hemmer - Felling

The two pieces of cloth should be laid, wrong side out, one over the other, with the edge of the under piece a little farther to the right than the upper piece, as shown in the illustration. Stitch the two pieces together, using the front projecting part of the hemmer as a guide for keeping the seam straight. This should be made close, but not too near to the edge of the upper piece, or the cloth will give way at the seam when a strain is put upon it.

Raise the hemmer foot and open the work out flat, wrong side up, so that the edges will stand up straight. Then push the edges at the beginning of the seam into the mouth of the hemmer, as far as the needle, and lower the hemmer foot. While stitching, keep the material perfectly flat, using both hands, and see that the seam is in line with the mouth of the hemmer. For the second seam, the stitch should be lengthened slightly.

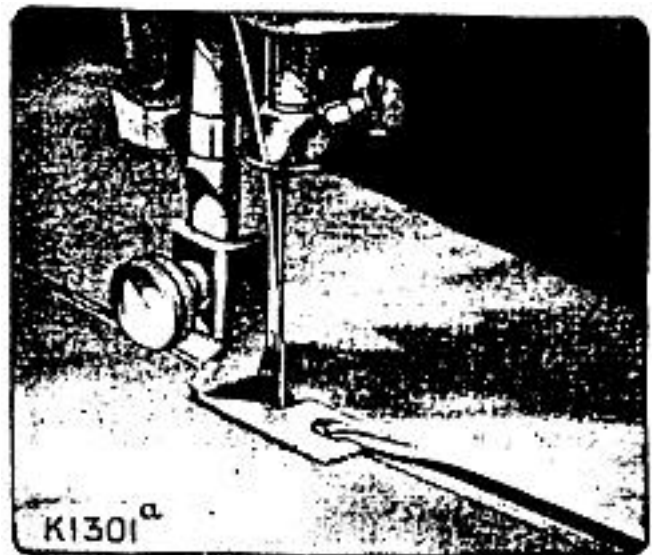
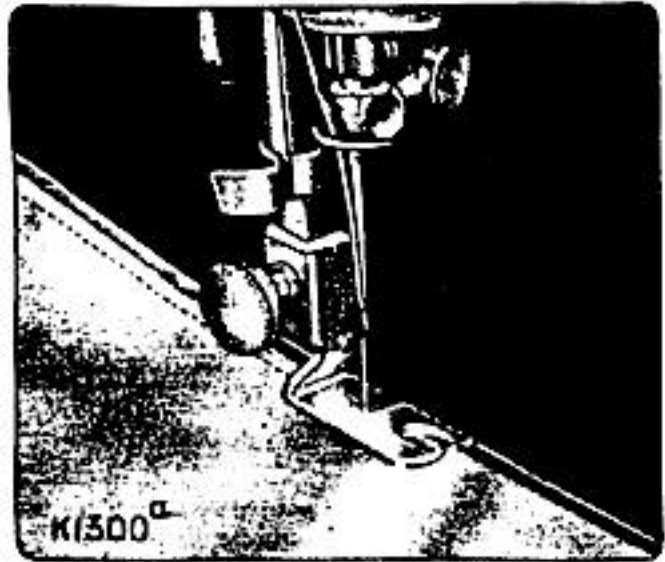

# SINGER

K1831  
(256) No. 28

## The Adjustable Hemmer

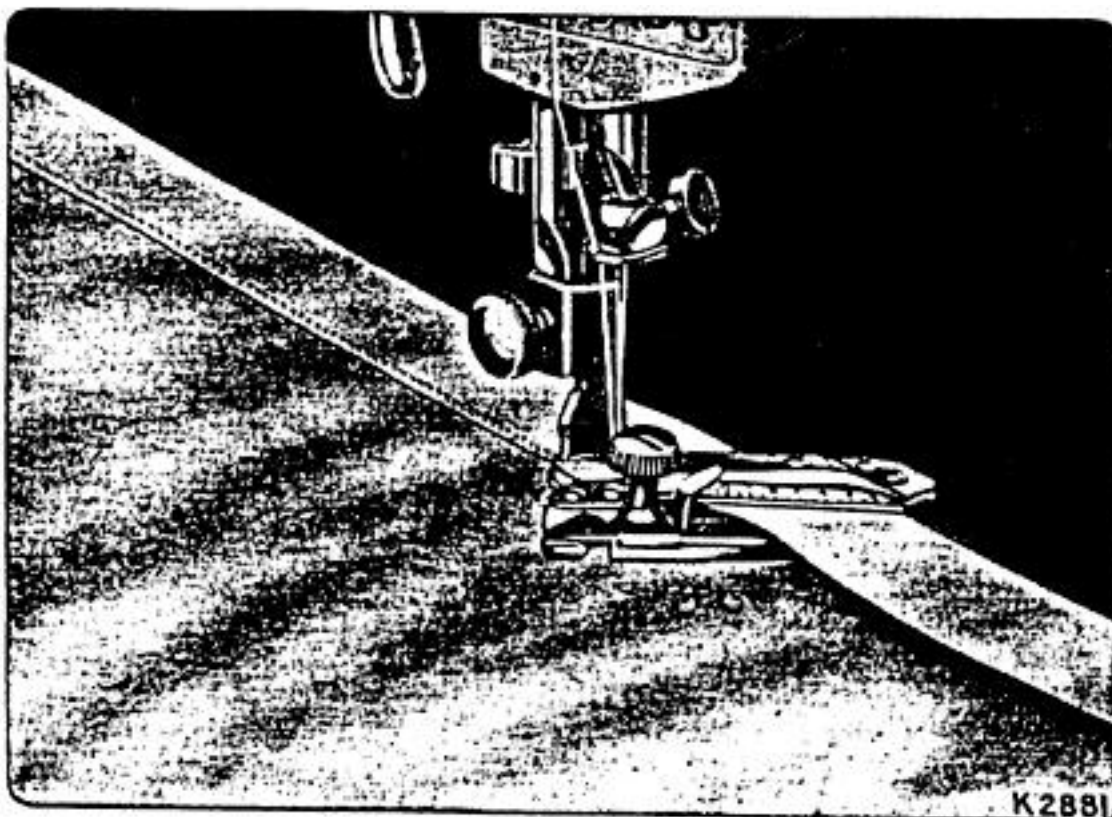

With its slide closed, the attachment will make hems up to one inch wide.

Loosen the screw at the front and move the slide until the pointer is against the desired width then tighten the screw. Insert the edge of the material between the slide and the number gauge, and draw it backward and forward until the hem is formed, stopping with its end under the needle. Lower the presser bar and sew, taking care in guiding the work to keep the hemmer full. Felling can also be done by following the felling instructions.



# SINGER

K1831  
(256) No. 28

## The Adjustable Hemmer - Wide Hemming

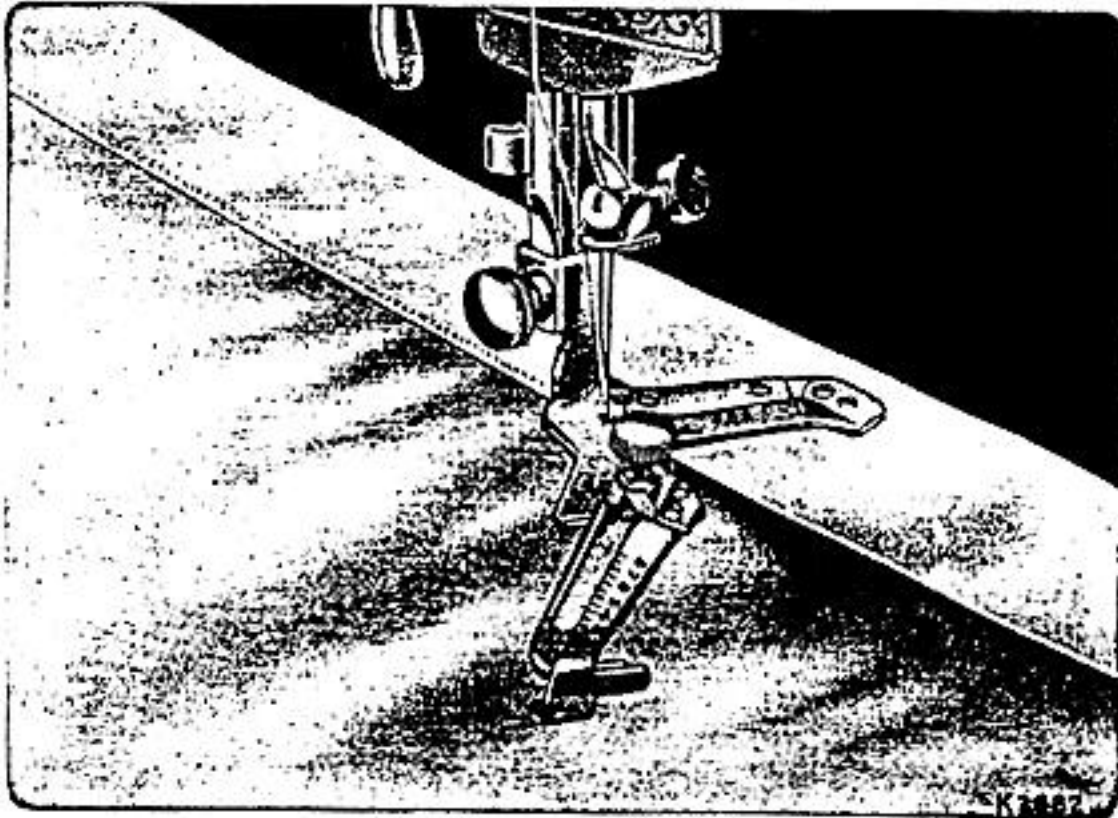

To make a hem more than one inch wide, loosen the screw, draw the slide to the right, as far as it will go, and turn it towards you, as in the illustration.

Fold and crease down a hem of the desired width, pass the fold under the extension at the right of the hemmer, then insert the edge of the material into the folder, and proceed to sew.

# SINGER

K1831  
(256) No. 28

## The Under Braider - Braiding

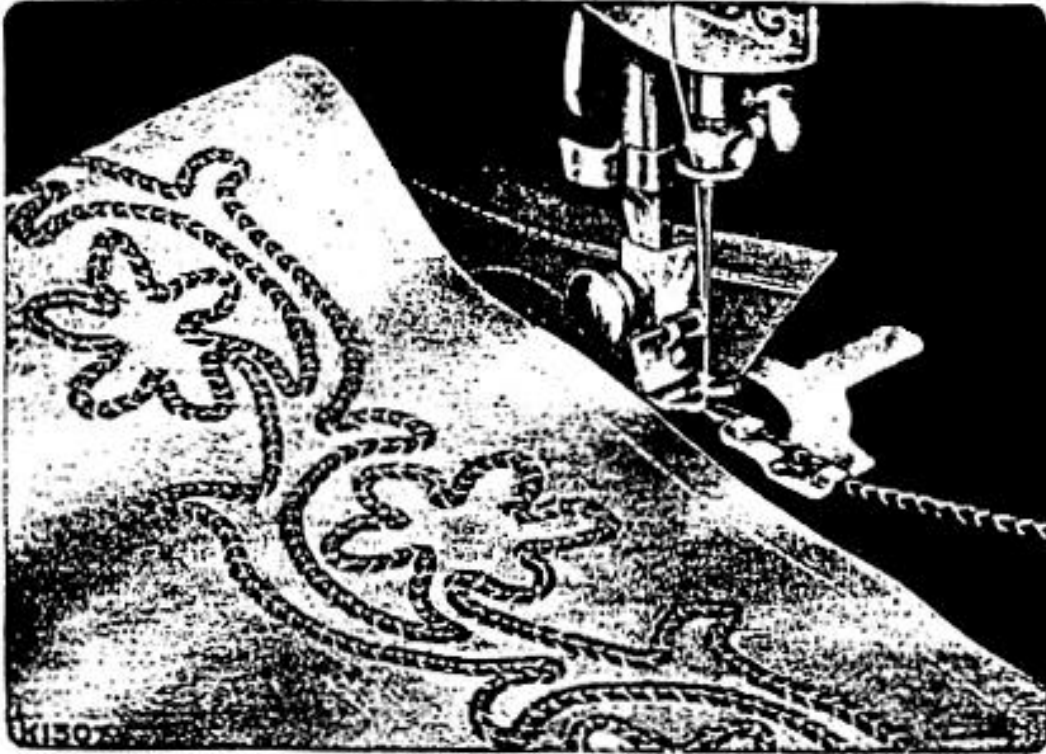

Fit the quilter foot, as shown.

To attach the under braider, draw the front and back slides that cover the shuttle, and insert the downward projecting parts of the attachment against the edge of the throat plate. Close first the back slide, then the front, so that the end of the front slide will enter the turned under part of the attachment and hold it firmly in position.

The pattern or design to be braided must be stamped or traced on the wrong side of the material. Pass the end of the braid through the guide of the under braider and then under the needle. Place the material, wrong side up, above the braid, lower the presser foot and proceed to sew, following the lines of the design.